

# Tourism and mobility in Catalonia

MONA Webinar: Removing Barriers – bringing the tourism and mobility sectors together

16 April 2026

Mr. Albert Guillaumes, Government of Catalonia

# 1

---

## Introduction

# Introduction

## About Catalonia

**8,154,627**

Population (2025)

**32,113 km<sup>2</sup>**

Area

**37,426 €**

GDP per capita



# Interurban bus network in Catalonia

- **Management:** Government of Catalonia
- **Operation:** concessions to private bus operators, ending in 2028

**90 million**  
passengers (2025)

**837**  
lines across Catalonia

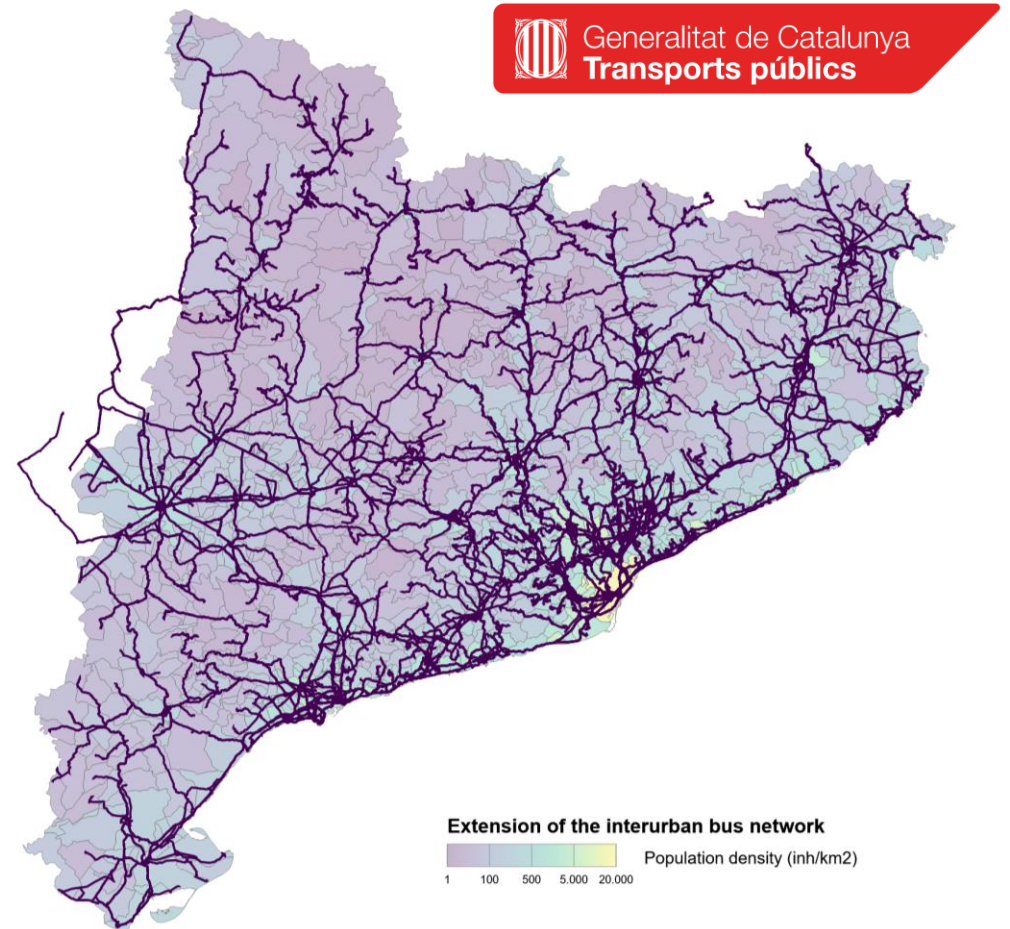

# 2

---

## Tourism in Catalonia

# Overview of tourism in Catalonia

**20 M**  
visitors in 2025\*

**Most visited region in Spain,**  
\*Excluding internal tourism of  
Catalan residents.

**85 M**  
nights spent in  
Catalonia

**3rd region in Spain** in terms of  
share of foreign visitors, only  
surpassed by the Canary Islands  
and the Balearic Islands

**64 %**  
foreign visitors

**4th region in the EU,** after the  
Canary Islands (Spain), Ile-de-  
France (France) and Dalmatia  
(Croatia)

**1.2 M**  
total number of  
beds

The city of **Barcelona** accounts  
for 12% of the total accomodation  
in Catalonia, followed by the  
coastal towns of Salou and

# Overview of tourism in Catalonia

**14 %**  
of GDP

Tourism accounts for the 14.6% of the Catalan GDP

**1,191€**  
average  
expenditure

Foreign tourists expend over 1,000 €

**541 k**  
jobs related to  
tourism

This accounts for the 14% of the workforce

# Overview of tourism in Catalonia

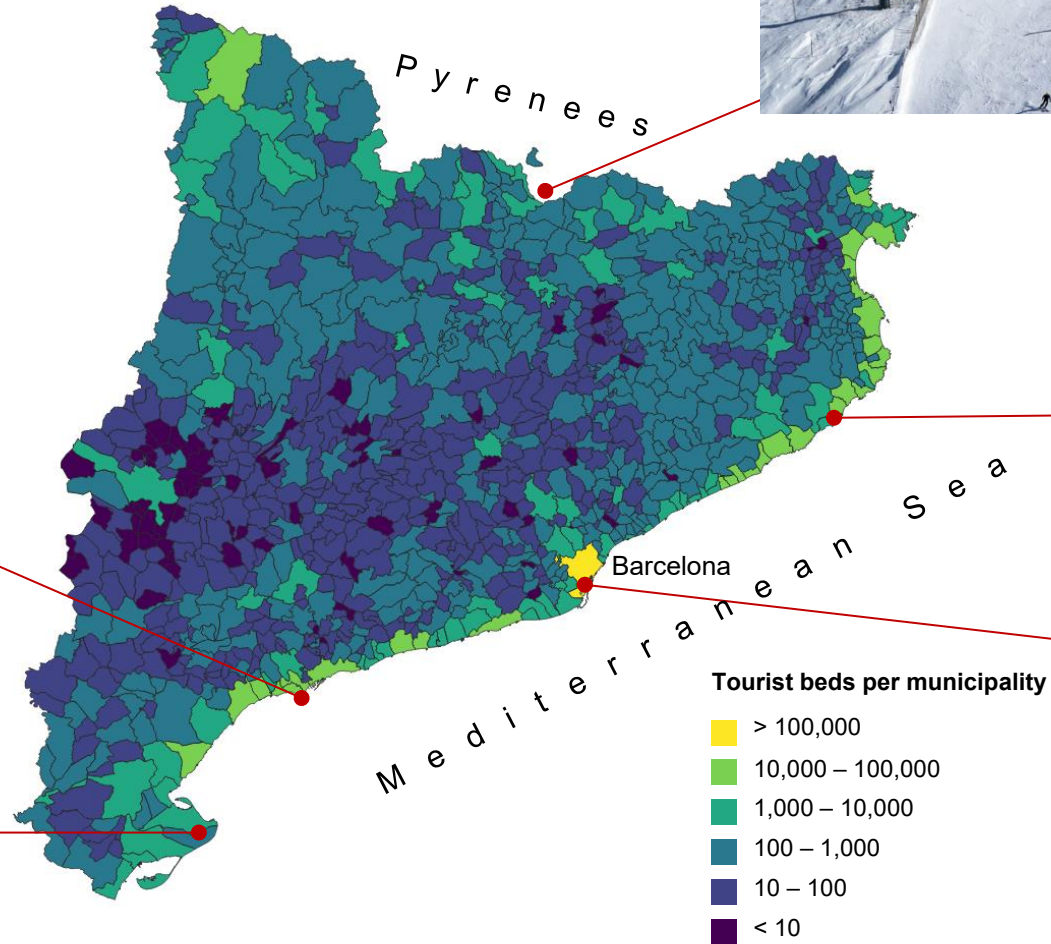

Font: Statistics Institute of Catalonia

# 3

---

## Actions related to tourism

# 3.1

---

## Public transport to nature parks



# Bus del Parc

## Aigüestortes i Estany de Sant Maurici National Park



Aigüestortes i Estany de Sant Maurici National Park

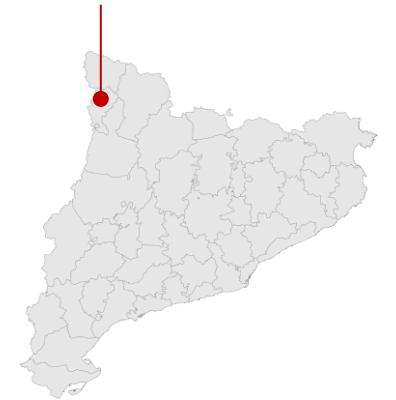

# Bus del Parc

## Aigüestortes i Estany de Sant Maurici National Park

- **Bus lines stoping at towns** next to the national park
- Operation: **3 bus lines** starting at la Pobla de Segur rail station
  - Bus la Pobla de Segur – Vielha – Pla de l'Ermita
  - Bus la Pobla de Segur – Sallente (Vall Fosca)
  - Bus la Pobla de Segur – el Pont de Suert
- Services run daily during school holidays (mid-June to mid-September), with 4 to 6 departures per day
- Reduced service during winter and school
- Integrated fares
- Funded by the Government of Catalonia



# Bus del Parc

## El Montseny



# Bus del Parc

## El Montseny

- Bus lines **from rail stations to the park**
- **Operation:** 4 bus lines
  - 436 Vic – Viladrau – el Brull
  - 484 Vic – Tona – el Brull
  - 573 Sant Celoni – Santa Fe
  - 576 Palautordera Station – Montseny
- Services run every weekend, with 3 to 14 daily trips per direction (depending on the line)
- Integrated fares
- Jointly funded by the Government of Catalonia and the Province of Barcelona

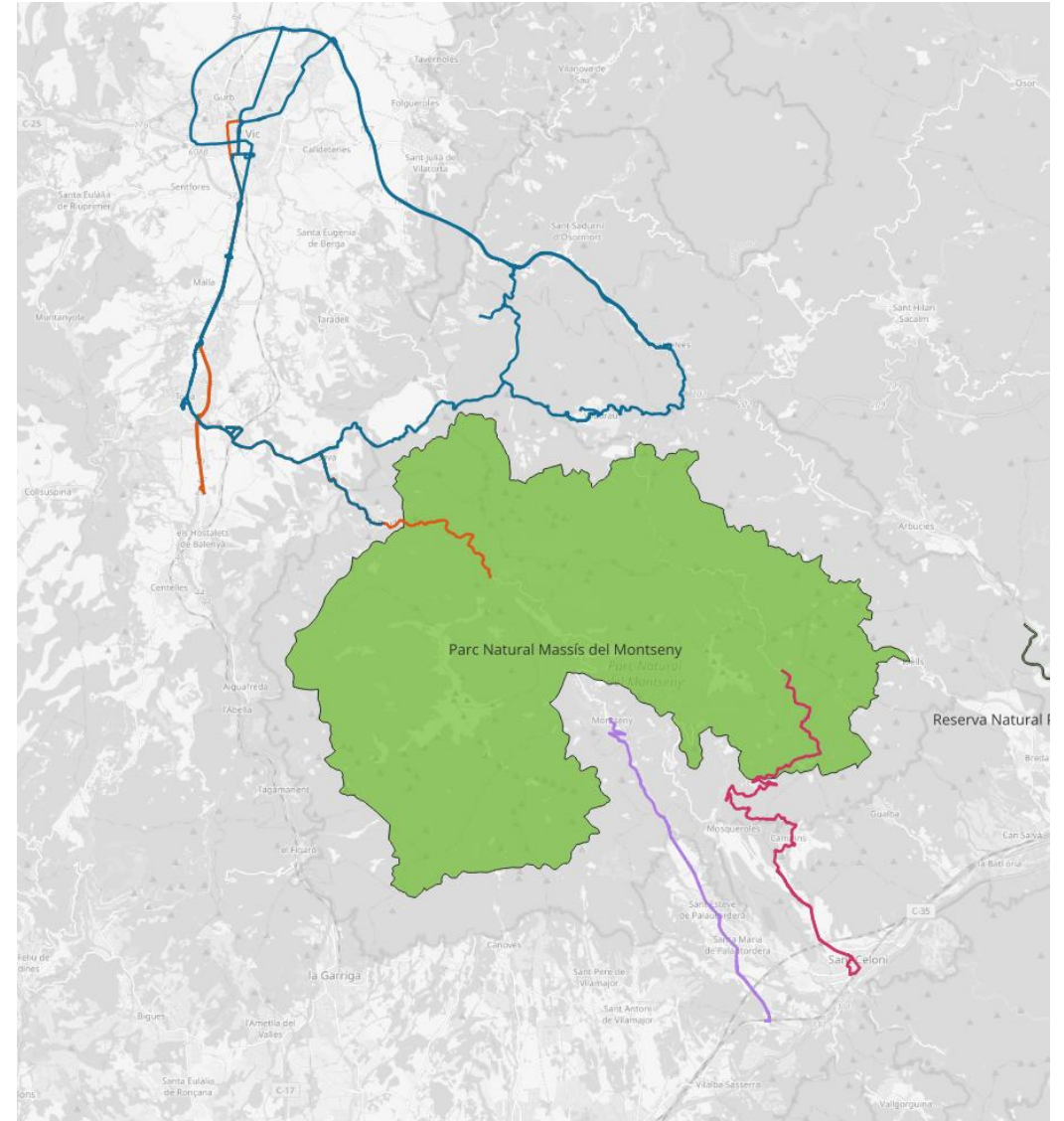

# Bus del Parc

## Zona Volcànica de la Garrotxa Natural Park



Zona Volcànica de la  
Garrotxa Nature Park



# Rumbus

## Zona Volcànica de la Garrotxa Natural Park

- Bus line calling at **towns, P+R and inside the park**
- Started in **2023**
- Operation: **1 shuttle line**
  - Les Preses – Olot – Santa Pau – Mieres
- Daily service:
  - Weekdays: 3 trips per direction
  - Winter weekends: 7 trips per direction
  - Summer: 14 trips per direction
- Integrated fares
- Return ticket: €2.00
- Funded by the Government of Catalonia



# 3.2

---

## Public transport in coastal areas

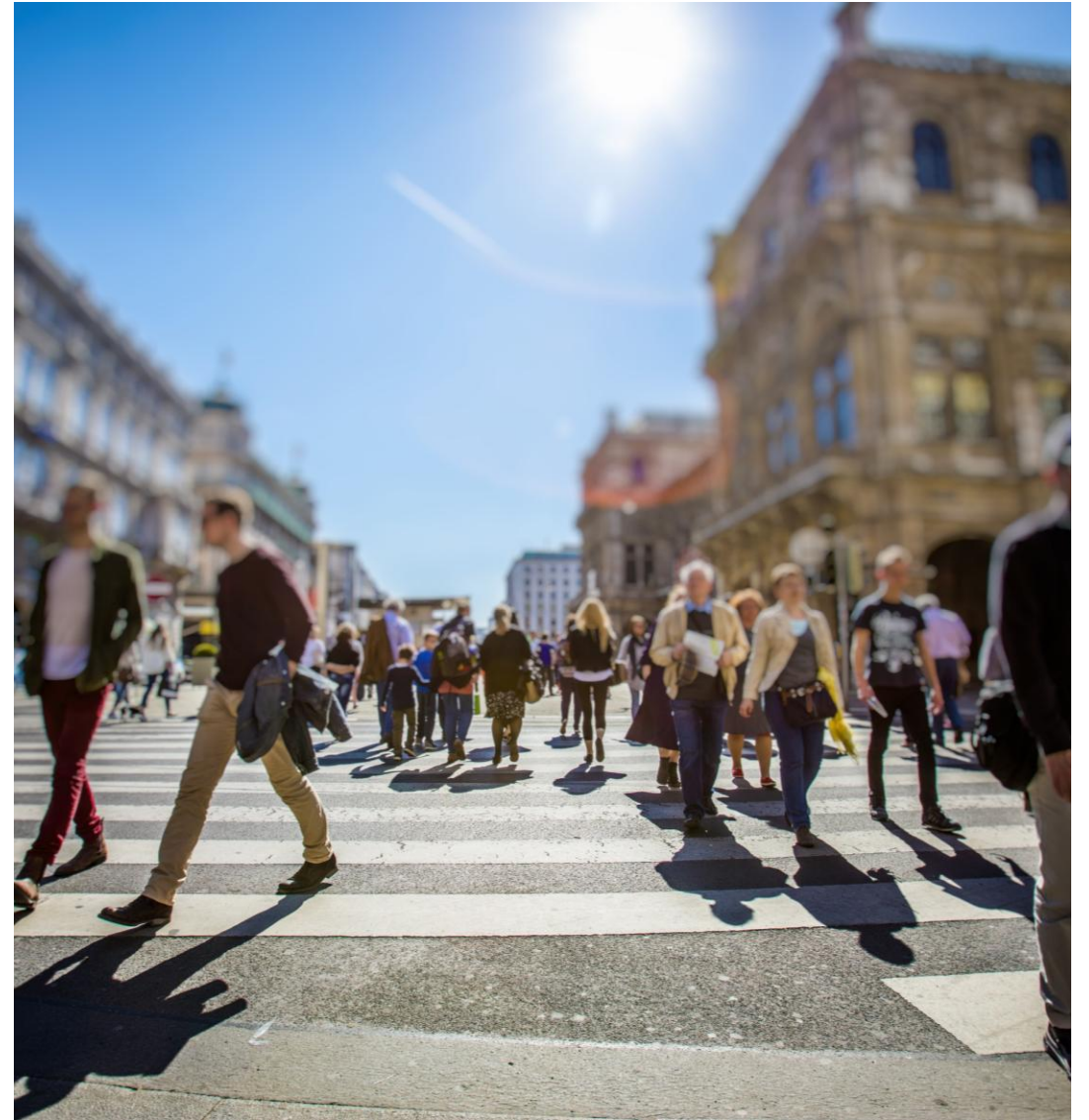

# Costa Daurada

## Camp de Tarragona



High speed rail station  
Barcelona – Madrid HSL  
Barcelona – Valencia HSL

Reus Airport



**Reus**  
Birthplace of Antoni Gaudí

**Salou, Cambrils, la Pineda**  
Beach towns, hotel resorts

**Tarragona**  
Provincial capital  
World Heritage (Roman City)

**Port Aventura**  
Theme park

# Costa Daurada

## Peak season and transport ridership

Ridership of regional buses (Barcelona 2025)

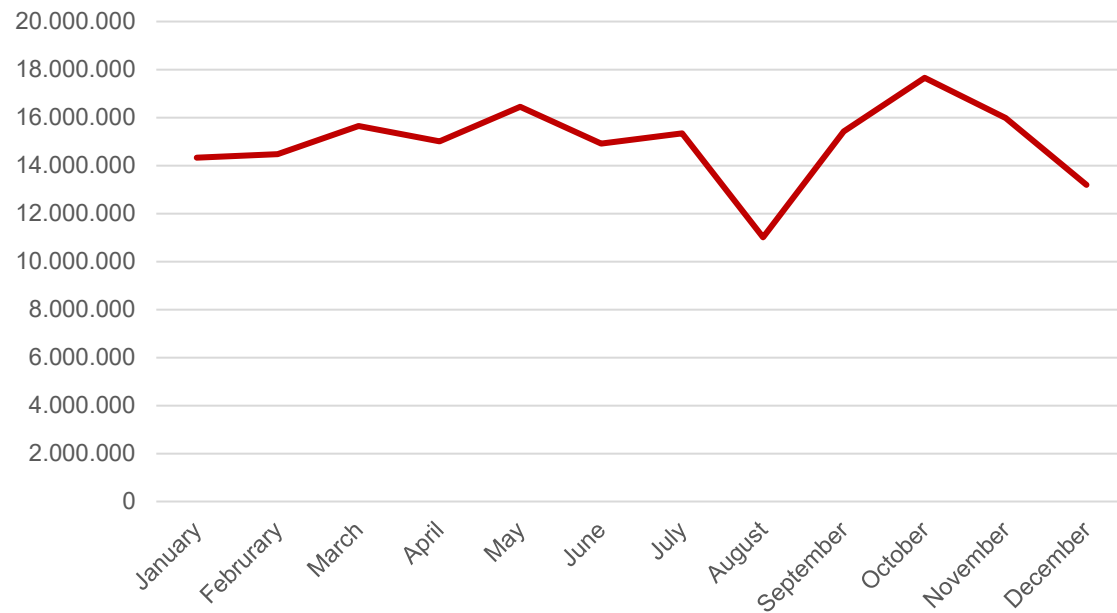

Ridership on regional buses (Tarragona 2025)

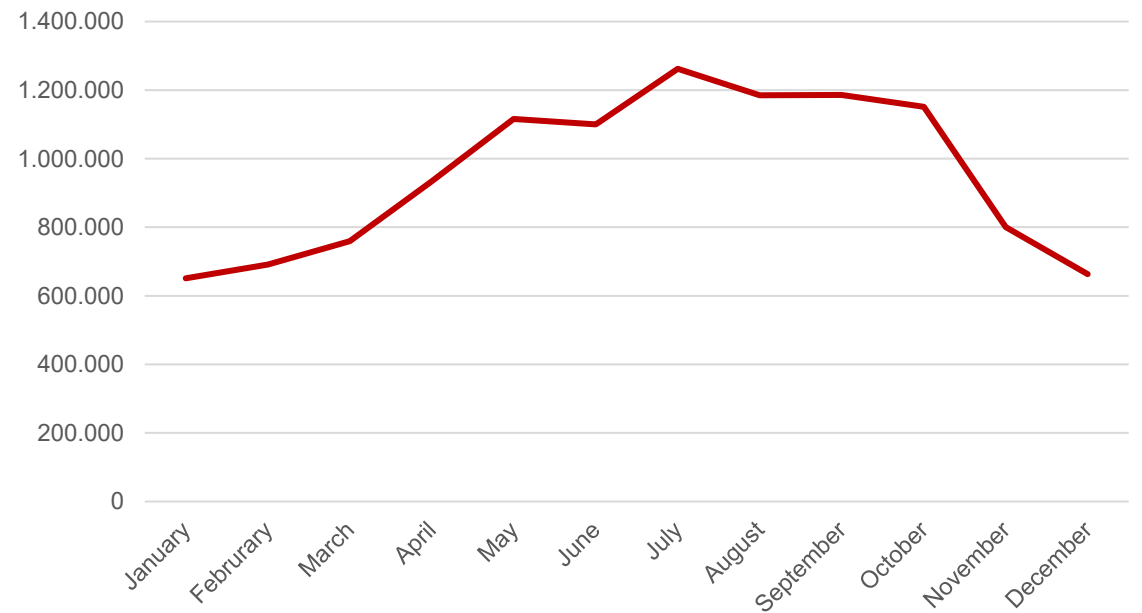

# Costa Daurada

## Reus Airport

Winter

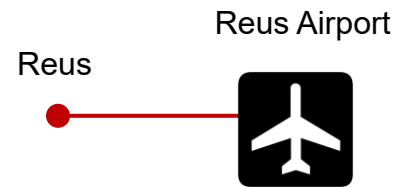

Summer

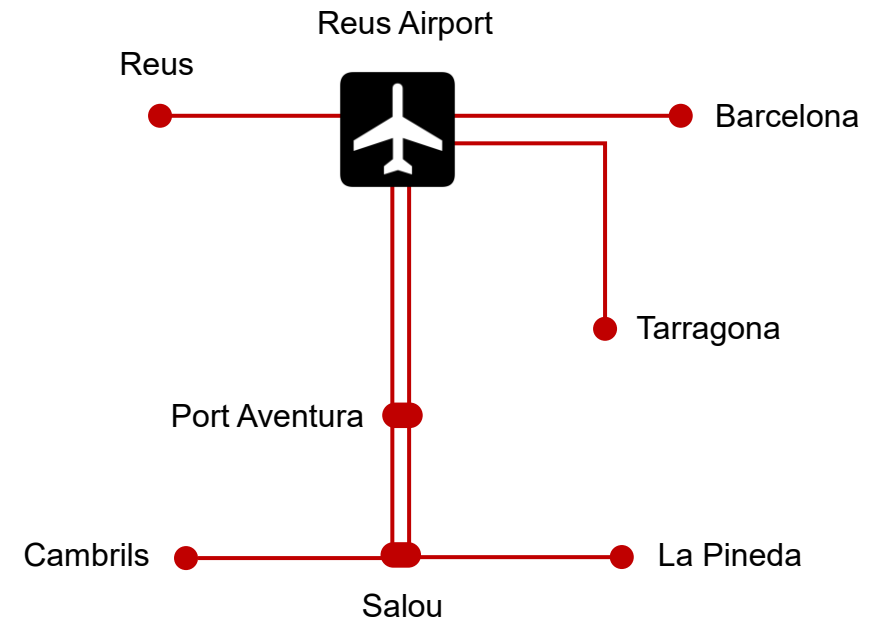

# Costa Daurada

## Camp de Tarragona high speed rail station

Winter

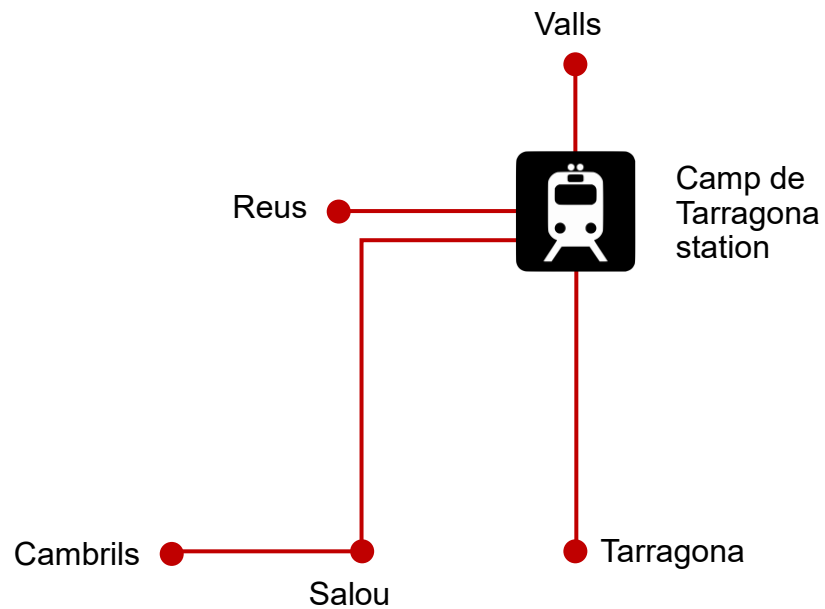

Summer

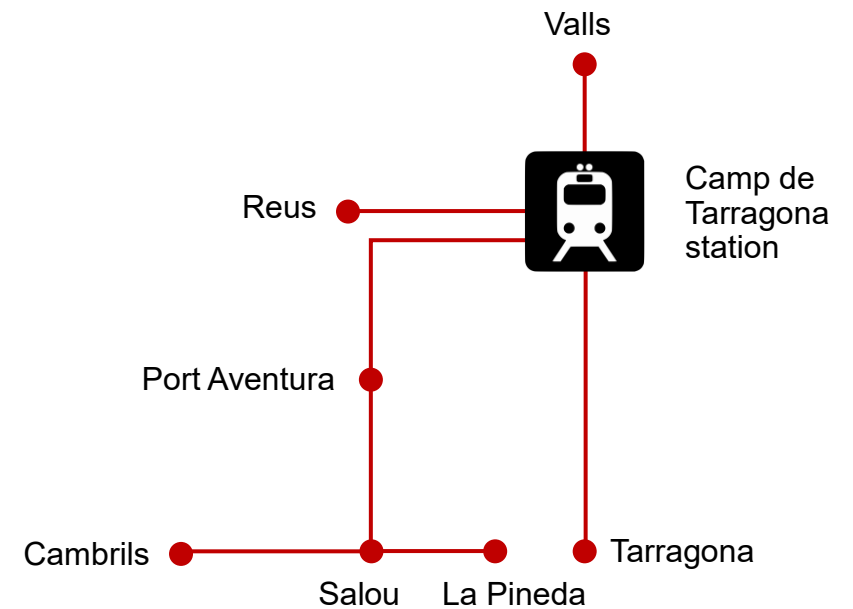



# Costa Daurada

## Cambrils – Salou – Tarragona corridor

Winter

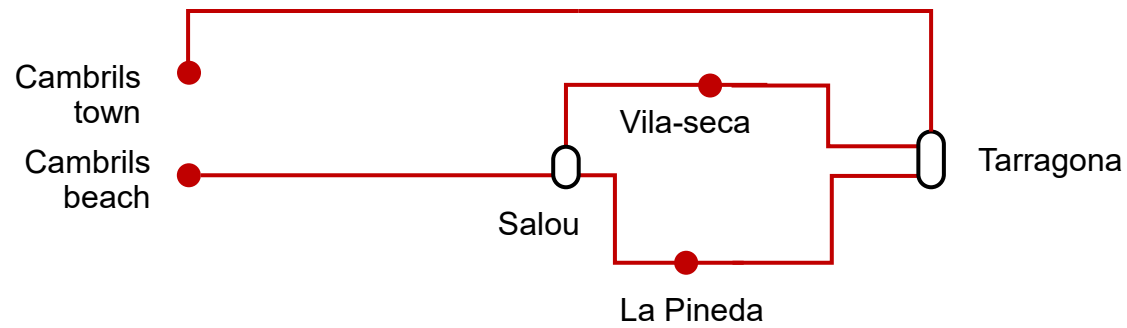

Summer

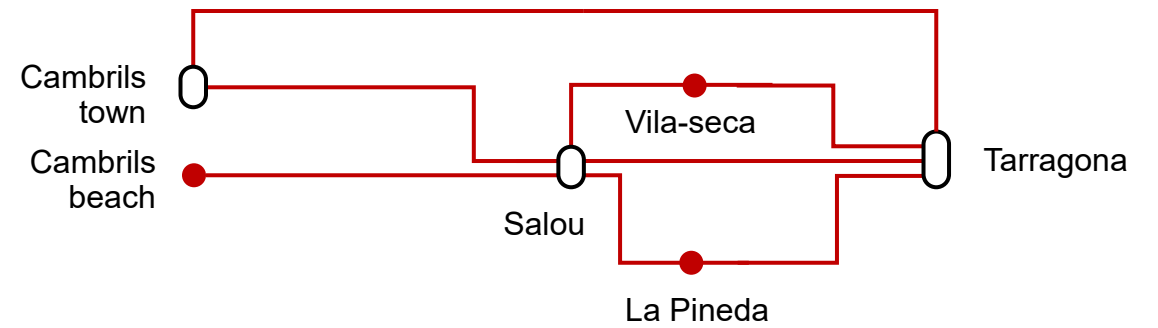



Government of Catalonia  
Directorate-General for Transport and Mobility

[territori.gencat.cat](http://territori.gencat.cat)

[dgtm.territori@gencat.cat](mailto:dgtm.territori@gencat.cat)